

Dual Switching Diode

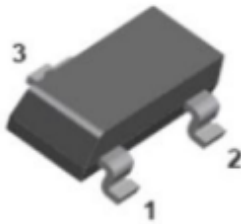
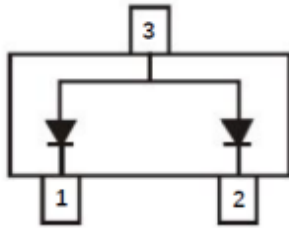

SOT-323

Features

- Moisture sensitivity level 1
- Reverse voltage: 80V
- Average forward current : 100mA

Application

- Signal switching
- High frequency rectifier

Mechanical data

- **Package:** SOT-323
- **Terminals:** Tin plated leads, solderable per J-STD-002 and JESD22-B102

■ Maximum Ratings (T_a=25°C Unless otherwise specified)

Parameter	Symbol	Unit	Value
Device marking code			P
Repetitive peak reverse voltage	V _{RRM}	V	80
Forward current, per leg	I _F	mA	100
Non-repetitive Surge peak forward current @ t=8.3ms half-sine wave	I _{FSM}	A	2
Non-repetitive Surge peak forward current @ t=1ms square wave			2
Power dissipation	P _D	mW	200
Junction temperature	T _J	°C	-55 to +150
Storage temperature	T _{STG}	°C	-55 to +150



DAP202U

RoHS
COMPLIANT

■ Electrical Characteristics (T_a=25°C Unless otherwise specified)

Parameter	Symbol	UNIT	Conditions	Min	TYP	Max
Reverse voltage	V _R	V	I _R =100uA	80		
Forward voltage	V _F	V	I _F =100mA			1.2
Reverse leakage current	I _R	uA	V _R =70V			0.2
Junction capacitance	C _j	pF	V _R =6V,f=1MHz			3.5
Reverse recovery time	T _{rr}	ns	I _F =I _R =5mA, V _R =6V,R _L =50Ω			4

■ Thermal Characteristics

Parameter	Symbol	Unit	Value
Thermal resistance, junction-to-ambient	R _{θJ-A} ⁽¹⁾	°C/W	625
Thermal resistance, junction-to-case	R _{θJ-C} ⁽¹⁾	°C/W	500

Note:

(1) Device mounted on PCB, single-sided copper, with standard footprint



■ Characteristics

Fig 1: P_D - T_a Curve

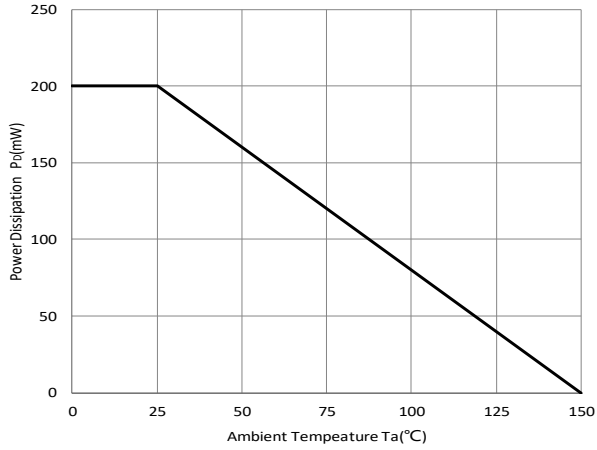

Fig 2: Capacitance Capability

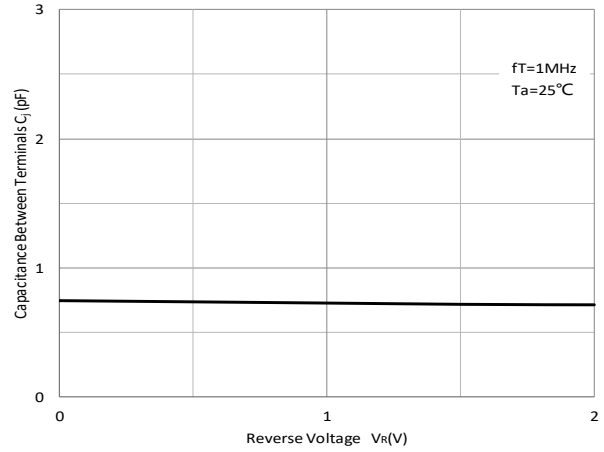

Fig 3: Typical Forward Characteristics

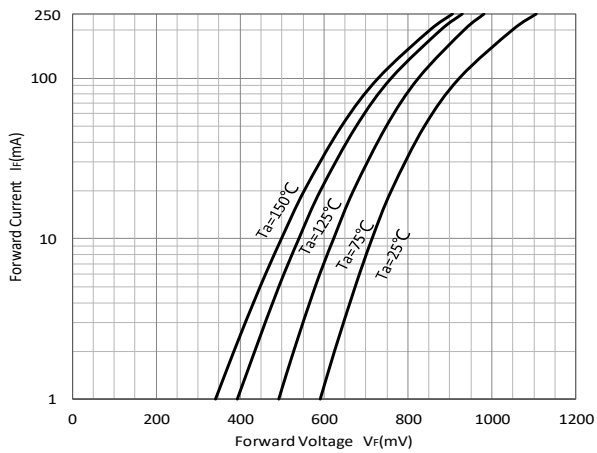
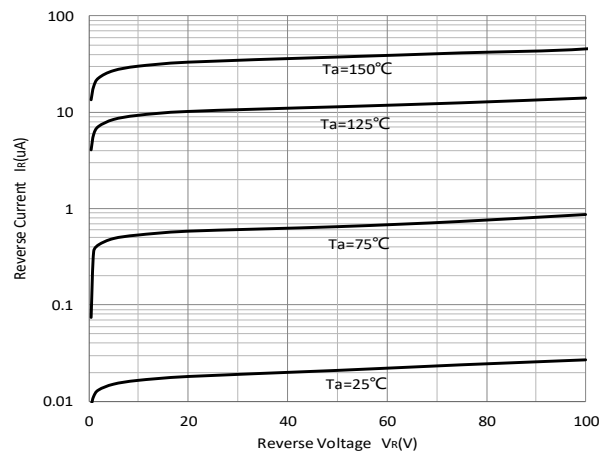

Fig 4: Typical Reverse Characteristics





DAP202U

RoHS
COMPLIANT

Ordering Information

Preferred P/N	Packing code	Unit weight(g)	Minimum package(pcs)	Inner box quantity(pcs)	Outer carton quantity (pcs)	Delivery mode
DAP202U	F2	Approximate 0.005	3000	30000	120000	7" reel

Outline Dimensions

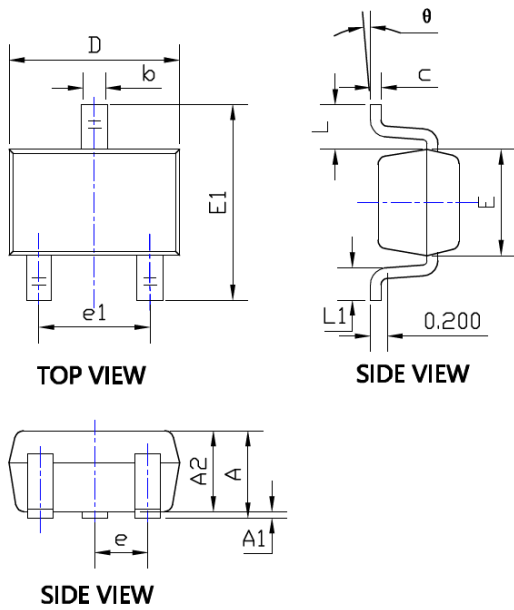

SYMBOL	DIMENSIONS			
	INCHES		Millimeter	
	MIN.	MAX.	MIN.	MAX.
A	0.035	0.043	0.900	1.100
A1	0.000	0.004	0.000	0.100
A2	0.035	0.039	0.900	1.000
b	0.006	0.016	0.150	0.400
c	0.004	0.010	0.100	0.250
D	0.071	0.087	1.800	2.200
E	0.045	0.053	1.150	1.350
E1	0.085	0.096	2.150	2.450
e	0.026TYP		0.650TYP	
e1	0.047	0.055	1.200	1.400
L	0.021REF		0.525REF	
L1	0.010	0.018	0.260	0.460
θ	0°	8°	0°	8°

Suggested Pad Layout

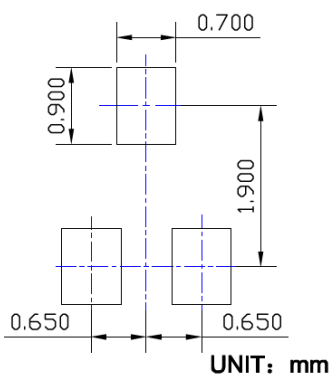



Disclaimer

The information presented in this document is for reference only. Yangzhou Yangjie Electronic Technology Co., Ltd. reserves the right to make changes without notice for the specification of the products displayed herein to improve reliability, function, or design or otherwise.

The product listed herein is designed to be used with ordinary electronic equipment or devices, and not designed to be used with equipment or devices which require high level of reliability and the malfunction of which would directly endanger human life (such as medical instruments, transportation equipment, aerospace machinery, nuclear-reactor controllers, fuel controllers and other safety devices), Yangjie or anyone on its behalf, assumes no responsibility or liability for any damages resulting from such improper use of sale.

This publication supersedes & replaces all information previously supplied. For additional information, please visit our website [http:// www.21yangjie.com](http://www.21yangjie.com) , or consult your nearest Yangjie's sales office for further assistance.