

Silicon Carbide Power MOSFET (N-Channel Enhancement)

| | |
|--------------|-------|
| V_{DS} | 1200V |
| I_D (25°C) | 62A |
| $R_{DS(on)}$ | 40mΩ |

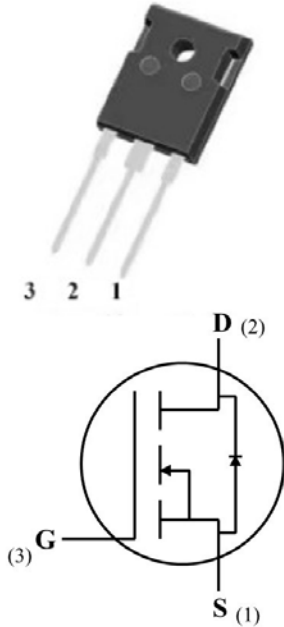

Features

- High speed switching
- Essentially no switching losses
- Reduction of heat sink requirements
- Maximum working temperature at 175 °C
- High blocking voltage
- Fast Intrinsic diode with low recovery current
- High-frequency operation
- Halogen free, RoHS compliant
- AEC-Q101 qualified

Typical Applications

Typical applications are in power factor correction(PFC), solar inverter, uninterruptible power supply, motor drives, photovoltaic inverter, electric car and charger.

Mechanical Data

- **Package:** TO247-AB
- **Terminals:** Tin plated leads
- **Polarity:** As marked

■ Maximum Ratings ($T_C=25^\circ\text{C}$ Unless otherwise specified)

| PARAMETER | SYMBOL | UNIT | VALUE | TEST CONDITIONS | NOTE |
|--|----------------|------|--------------|---|--------|
| Device marking code | | | D212040NCTGH | | |
| Drain source voltage @ $T_J=25^\circ\text{C}$ | $V_{DS,max}$ | V | 1200 | $V_{GS}=0\text{ V}, I_D=100\mu\text{A}$ | |
| Gate source voltage @ $T_J=25^\circ\text{C}$ | $V_{GS,max}$ | V | -10/+25 | Absolute maximum values (AC f > 1Hz, duty cycle < 1%) | Note1 |
| Gate source voltage @ $T_J=25^\circ\text{C}$ | $V_{GS,op}$ | V | -5/+20 | Recommended operational values | |
| Continuous drain current @ $T_C=25^\circ\text{C}$ | I_D | A | 62 | $V_{GS}=20\text{V}, T_C=25^\circ\text{C}$ | Fig.14 |
| Continuous drain current @ $T_C=110^\circ\text{C}$ | | | 42 | $V_{GS}=20\text{V}, T_C=110^\circ\text{C}$ | |
| Pulse Drain Current | $I_{D,pulse}$ | A | 238 | Limited by t_{pw} | Fig.15 |
| Avalanche energy, Single Pulse | E_{AS} | mJ | 650 | $V_{DD}=75\text{V}, L=30\text{mH}$ | |
| Power Dissipation | P_{TOT} | W | 326 | $T_C=25^\circ\text{C}, T_J = 175^\circ\text{C}$ | Fig.13 |
| Operating junction and Storage temperature range | T_J, T_{stg} | °C | -55 to +175 | | |
| Soldering temperature | T_L | °C | 260 | 1.6mm (0.063") from case for 10s | |
| Mounting torque | T_M | Nm | 0.6 | M3 screw Maximum of mounting process: 3 | |



■Static Electrical Characteristics (Tc=25°C unless otherwise specified)

| PARAMETER | SYMBOL | UNIT | Min. | Typ. | Max. | Test Conditions | Note |
|--|---------------|------|------|------|------|--|-------------|
| Gate threshold voltage | $V_{GS(th)}$ | V | 1.5 | 2.7 | 4.0 | $V_{DS}=V_{GS}, I_D=40mA$ | Fig.4, 11 |
| Drain source breakdown voltage | $V_{(BR)DSS}$ | V | 1200 | | | $V_{GS}=0, I_D=100\mu A$ | |
| Zero gate voltage drain current | I_{DSS} | uA | | <1 | 50 | $V_{DS}=1200V, V_{GS}=0V$ | |
| | | | | 10 | 500 | $V_{DS}=1200V, V_{GS}=0V, T_J=175^\circ C$ | |
| Gate source leakage current | I_{GSS} | nA | | | 250 | $V_{GS}=20V, V_{DS}=0V$ | |
| Current drain source on-state resistance | $R_{DS(on)}$ | mΩ | | 40 | 52 | $V_{GS}=20V, I_D=30A$ | Fig.3, 5, 6 |
| | | | | 75 | | $V_{GS}=20V, I_D=30A, T_J=175^\circ C$ | |
| Transconductance | g_f | S | | 15 | | $V_{DS}=20V, I_D=30A$ | |

■Dynamic Electrical Characteristics (Tc=25°C unless otherwise specified)

| PARAMETER | SYMBOL | UNIT | Min. | Typ. | Max. | Test Conditions | Note |
|--------------------------|--------------|------|------|------|------|---|--------|
| Input capacitance | C_{iss} | pF | | 3619 | | $V_{DS}=800V, V_{GS}=0V, T_J=25^\circ C, f=1MHz, V_{AC}=25mV$ | Fig.10 |
| Output capacitance | C_{oss} | | | 145 | | | |
| Reverse capacitance | C_{rss} | | | 18 | | | |
| Coss stored energy | E_{oss} | uJ | | 59 | | | Fig.12 |
| Gate source charge | Q_{gs} | nC | | 68 | | $V_{DS}=800V, V_{GS}=-5/20V, I_D=30A$ | Fig.16 |
| Gate drain charge | Q_{gd} | | | 66 | | | |
| Gate charge | Q_g | | | 229 | | | |
| Internal Gate Resistance | $R_{G(int)}$ | Ω | | 2.0 | 5.0 | $f=1MHz, V_{AC}=25mV$ | |

■Switching Characteristics (Tc=25°C unless otherwise specified)

| PARAMETER | SYMBOL | UNIT | Min. | Typ. | Max. | Test Conditions | Note |
|---------------------------|--------------|------|------|-------|------|--|------------|
| Turn on delay time | $t_{d(on)}$ | ns | | 27.3 | | $V_{DD}=800V, V_{GS}=-5/+20V, I_D=30A, L=100\mu H, R_{G(ext)}=2.7\Omega$ | Fig.17, 18 |
| Rise time | t_r | | | 24.9 | | | |
| Turn off delay time | $t_{d(off)}$ | | | 36.5 | | | |
| Fall time | t_f | | | 18.8 | | | |
| Turn on switching energy | E_{on} | uJ | | 836.8 | | | |
| Turn off switching energy | E_{off} | | | 173.6 | | | |



■Body diode characteristics (T_c=25°C unless otherwise specified)

| PARAMETER | SYMBOL | UNIT | Min. | Typ. | Max. | Test Conditions | Note |
|----------------------------------|------------------|------|------|------|------|---|-------|
| Diode forward voltage | V _{SD} | V | | 3.8 | | V _{GS} =0V, I _{SD} =15A | Fig.8 |
| Continuous diode forward current | I _s | A | | 50 | | V _{GS} =0V, T _c =25°C | |
| Reverse recovery time | t _{rr} | nS | | 65 | | V _{DS} =800V, V _{GS} =0V, I _{SD} =15A, di/dt=300A/uS | |
| Reverse recovery charge | Q _{rr} | nC | | 160 | | | |
| Peak reverse recovery current | I _{rrm} | A | | 4.3 | | | |

Note 1: When using SiC Body Diode the maximum recommended V_{GS} = -5V

■Thermal Characteristics (T_a=25°C Unless otherwise specified)

| PARAMETER | SYMBOL | UNIT | Value |
|--------------------|-------------------|------|-------|
| Thermal resistance | R _{θJ-C} | °C/W | 0.46 |

■Typical Characteristics

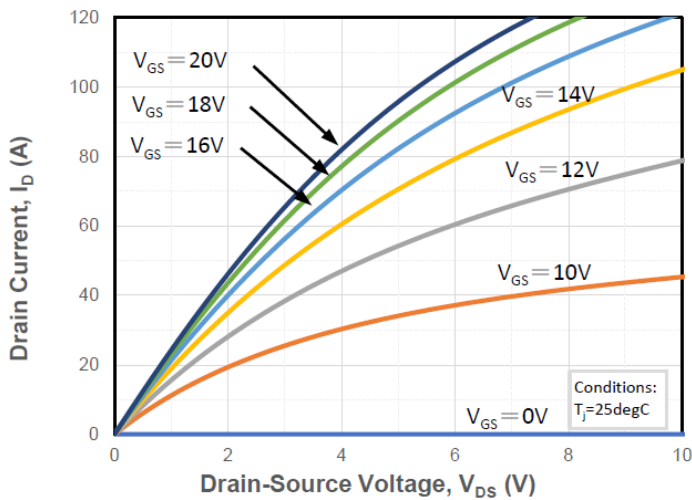

Figure 1. Output Characteristics T_j = 25°C

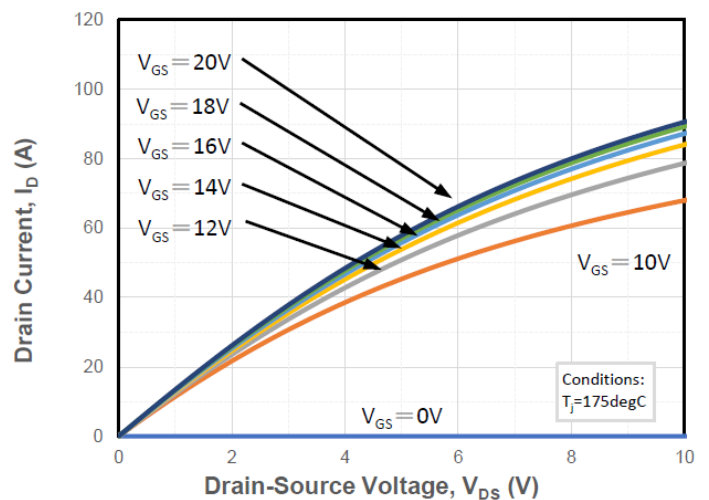

Figure 2. Output Characteristics T_j = 175°C

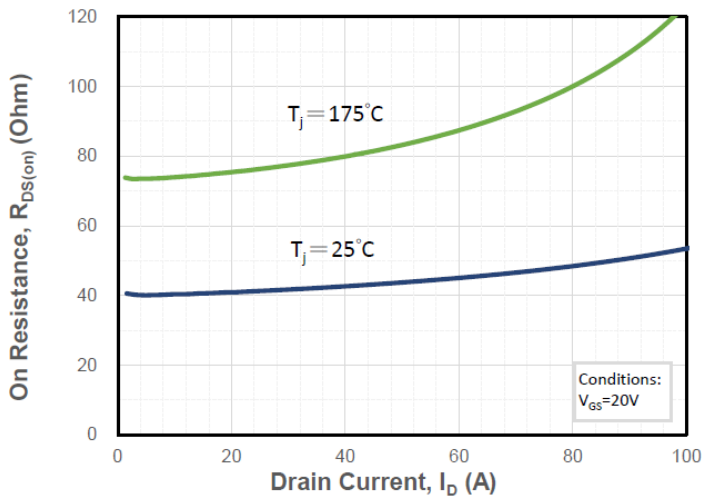

Figure 3. On-resistance vs. drain current

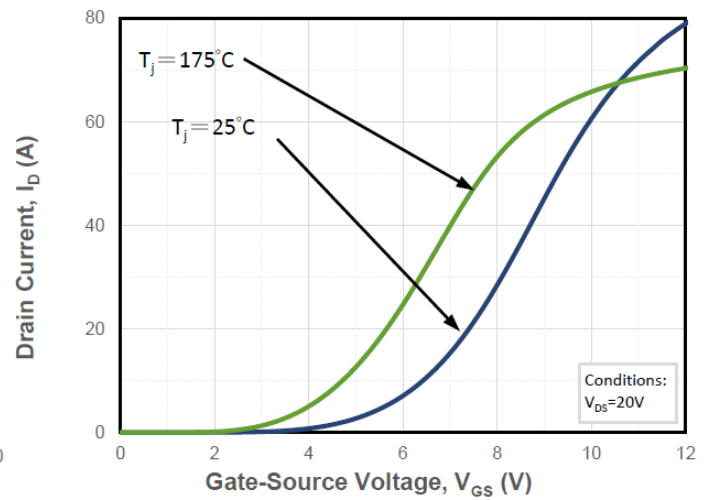

Figure 4. Transfer Characteristics for various Tj

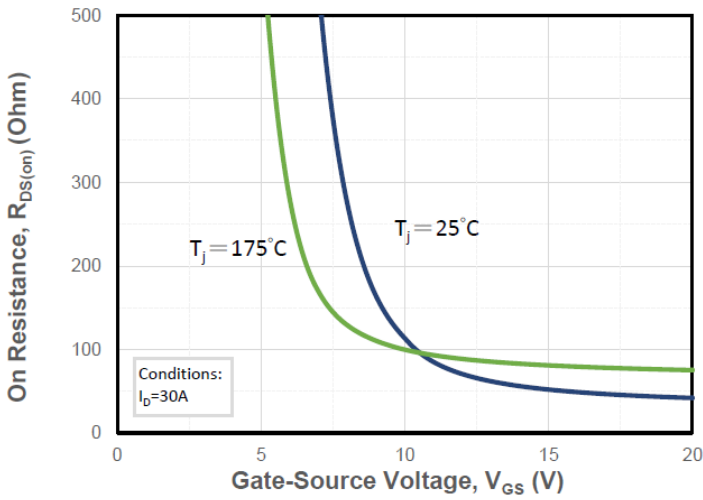

Figure 5. On-resistance vs. gate voltage for various Tj

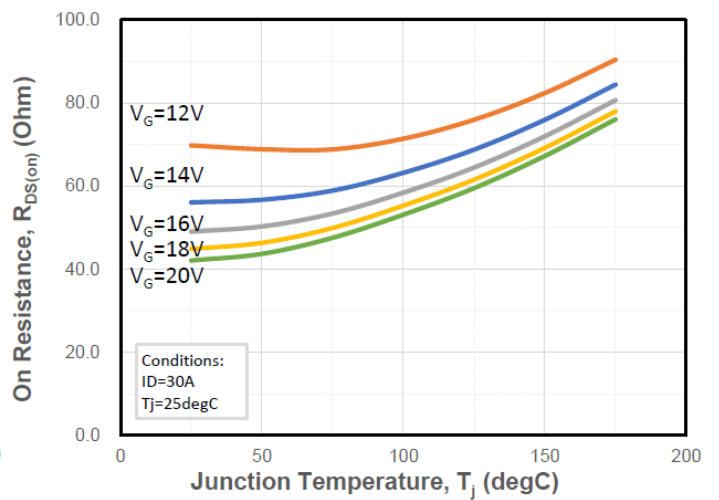

Figure 6. On-resistance vs. Temperature for various Gate voltage

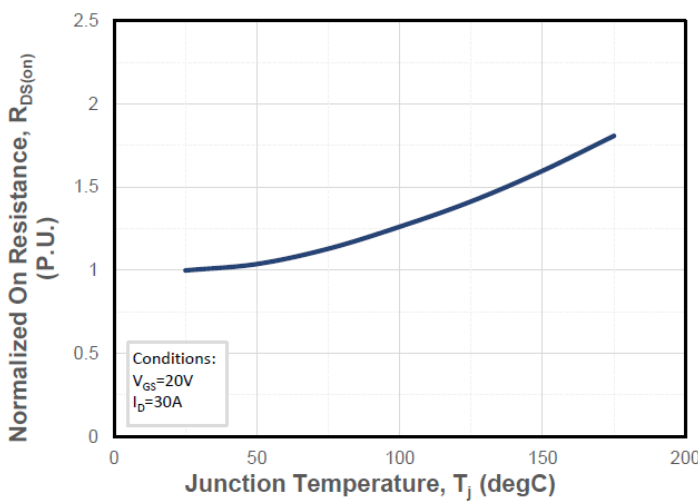

Figure 7. Normalized On-Resistance vs. Temperature

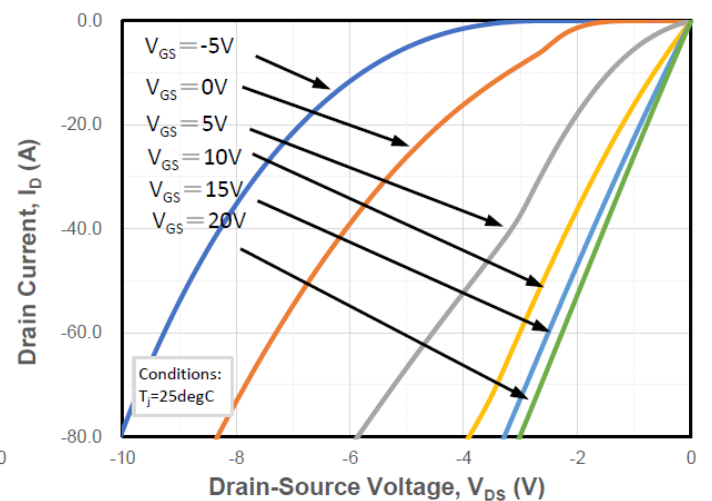

Figure 8. Reverse Output Characteristics at Tj = 25°C

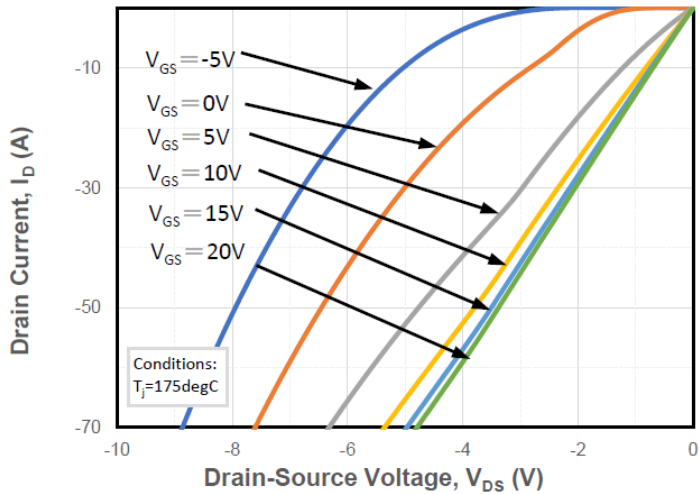

Figure 9. Reverse Output Characteristics at Tj = 175°C

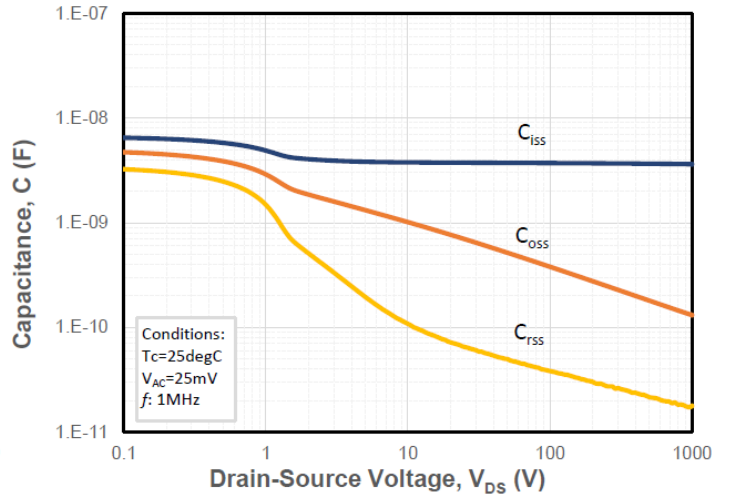

Figure 10. Capacitances vs. Drain to Source Voltage

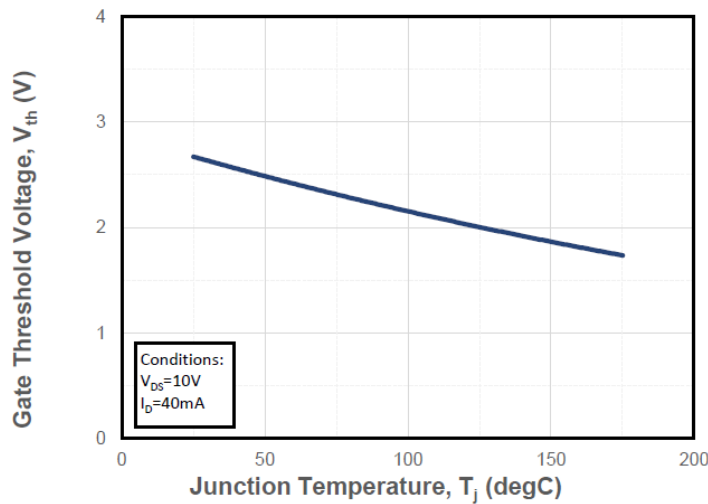

Figure 11. Threshold voltage vs. temperature

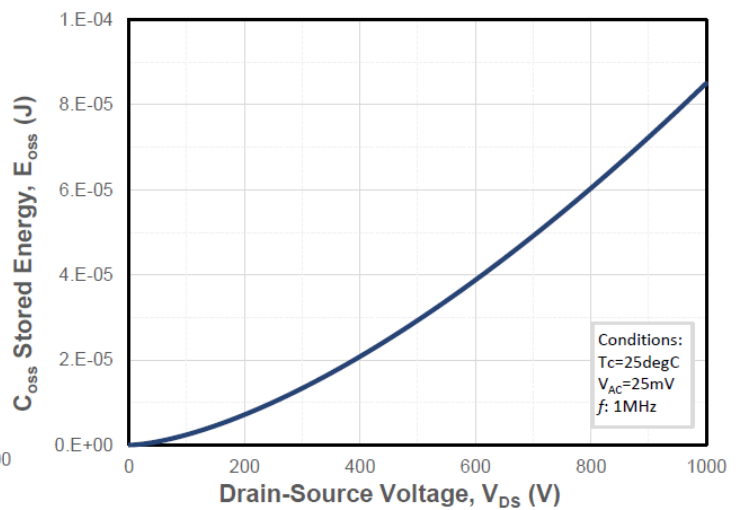

Figure 12. Output Capacitor Stored Energy

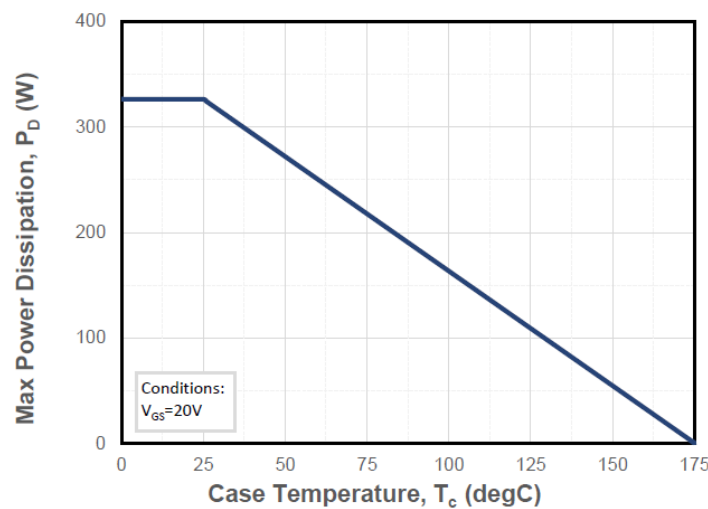

Figure 13. Maximum Power Dissipation Derating vs. Case Temperature

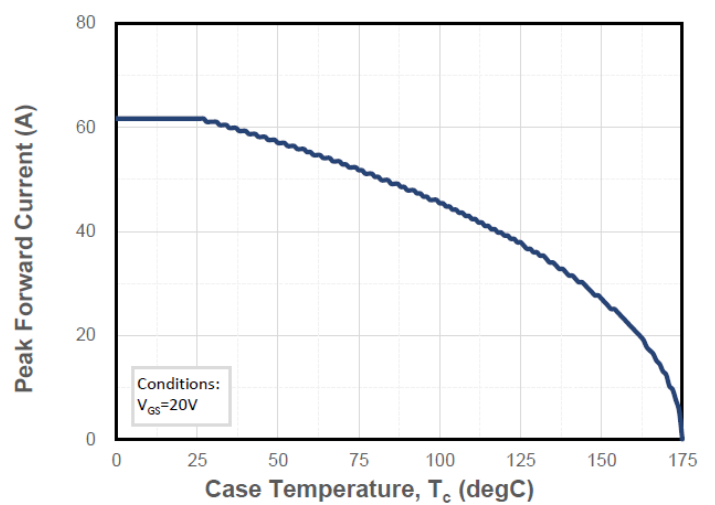

Figure 14. Drain Current Derating vs. Case Temperature

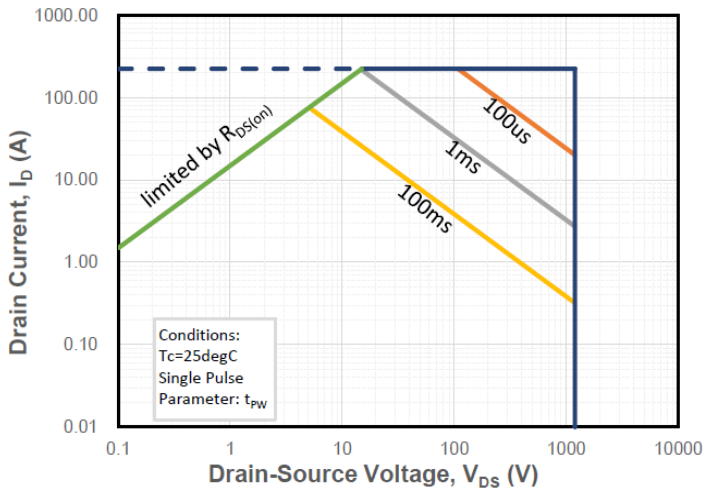

Figure 15. Safe Operating Area

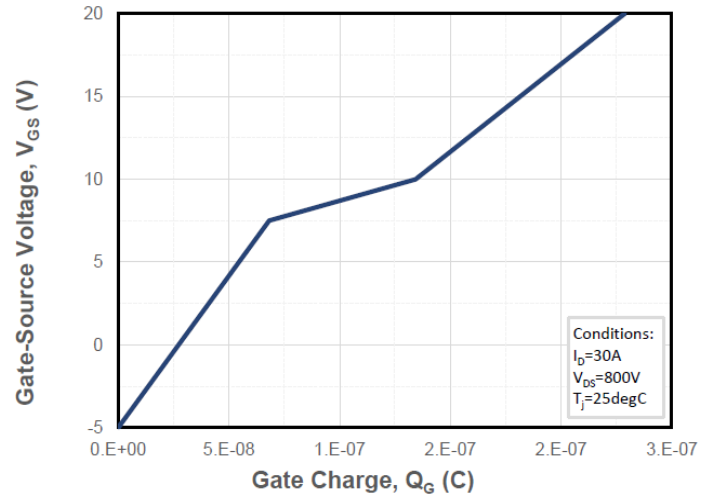

Figure 16. Gate Charge Characteristics

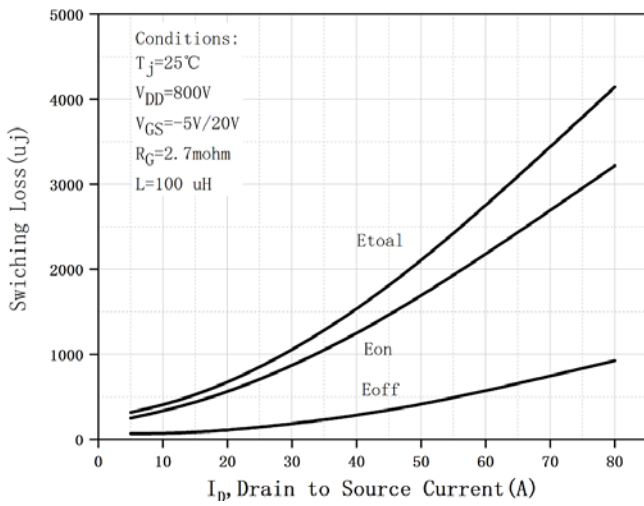

Figure 17. Clamped Inductive Switching Energy vs. Drain Current

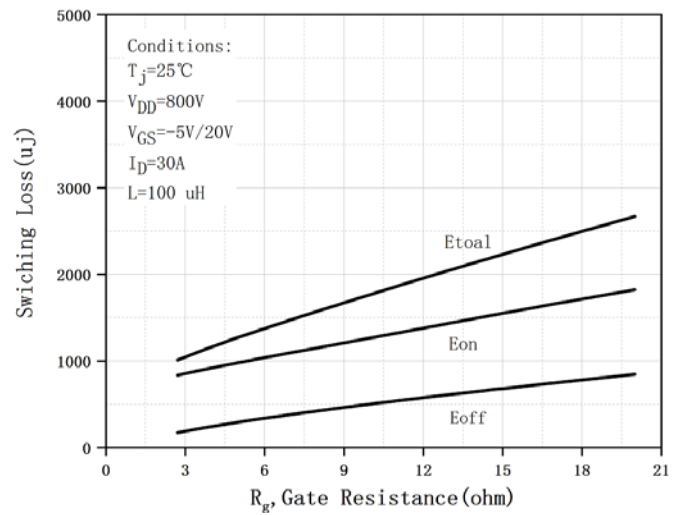

Figure 18. Clamped Inductive Switching Energy vs. External Gate Resistor ($R_{G(ext.)}$)

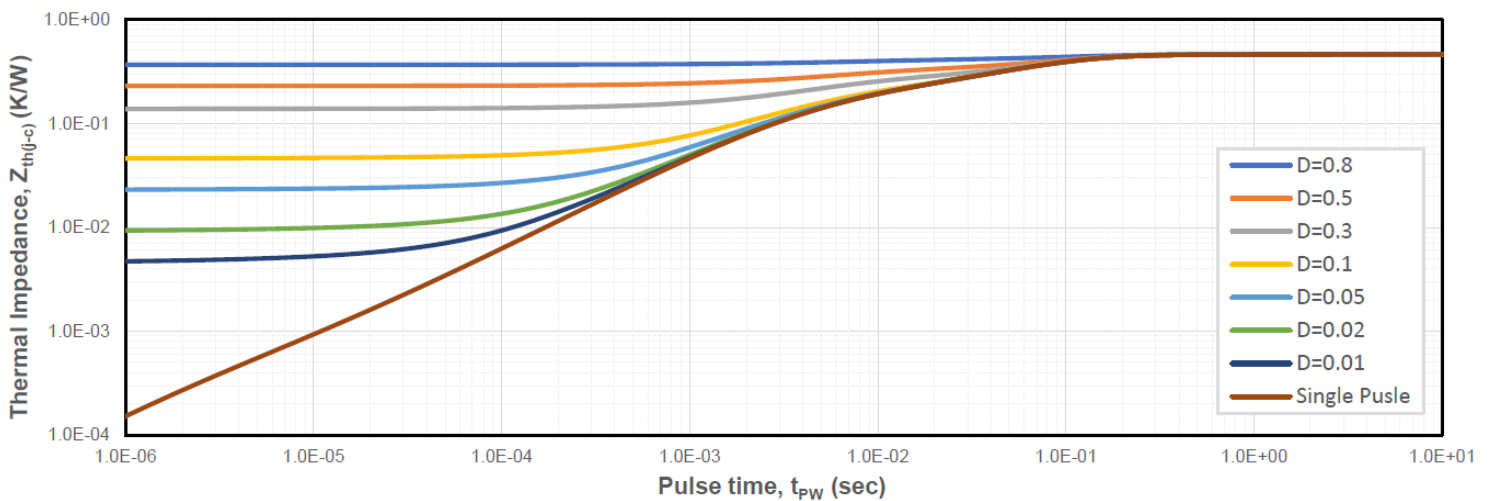

Figure 19. Transient Junction to Case Thermal Impedance

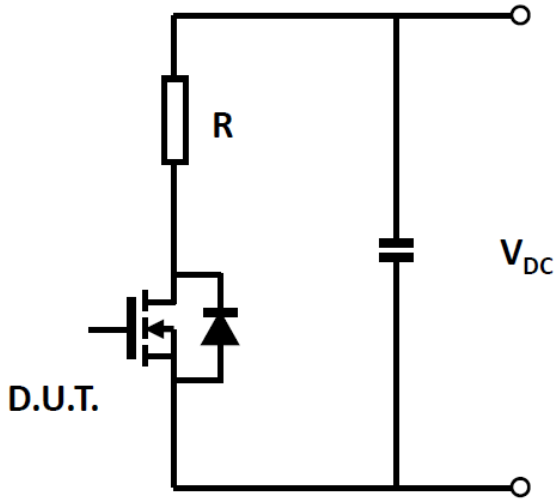

Figure 20. Schematic of Resistive Switching

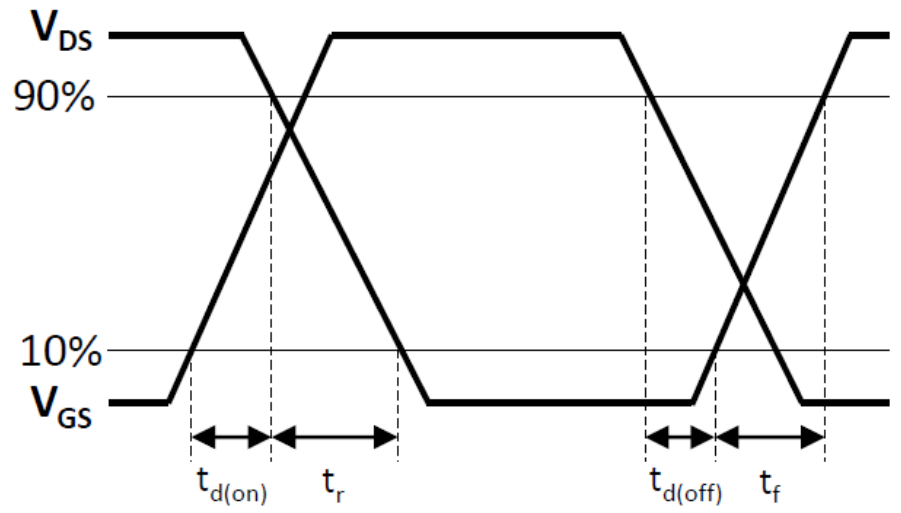
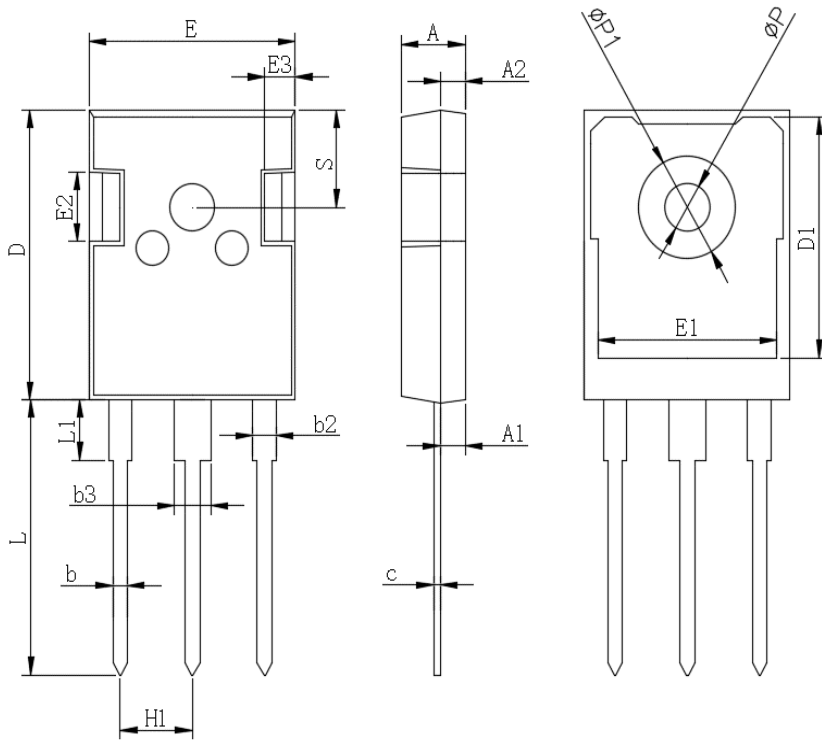

Figure 21. Switching Times Definition

■Outline Dimensions

TO-247AB



| TO-247AB | | |
|----------|---------|-------|
| Dim | Min | Max |
| A | 4.80 | 5.20 |
| A1 | 2.21 | 2.61 |
| A2 | 1.85 | 2.15 |
| b | 1.0 | 1.4 |
| b2 | 1.91 | 2.21 |
| C | 0.5 | 0.7 |
| D | 20.70 | 21.30 |
| D1 | 16.25 | 16.85 |
| E | 15.50 | 16.10 |
| E1 | 13.0 | 13.6 |
| E2 | 4.80 | 5.20 |
| E3 | 2.30 | 2.70 |
| L | 19.62 | 20.22 |
| L1 | - | 4.30 |
| φP | 3.40 | 3.80 |
| φP1 | - | 7.30 |
| S | 6.15TYP | |
| H1 | 5.44TYP | |
| b3 | 2.80 | 3.20 |



Disclaimer

The information presented in this document is for reference only. Yangzhou Yangjie Electronic Technology Co., Ltd. reserves the right to make changes without notice for the specification of the products displayed herein to improve reliability, function or design or otherwise.

The product listed herein is designed to be used with ordinary electronic equipment or devices, and not designed to be used with equipment or devices which require high level of reliability and the malfunction of which would directly endanger human life (such as medical instruments, transportation equipment, aerospace machinery, nuclear-reactor controllers, fuel controllers and other safety devices), Yangjie or anyone on its behalf, assumes no responsibility or liability for any damages resulting from such improper use of sale.

This publication supersedes & replaces all information previously supplied. For additional information, please visit our website [http:// www.21yangjie.com](http://www.21yangjie.com) , or consult your nearest Yangjie's sales office for further assistance.