

Schottky Diodes

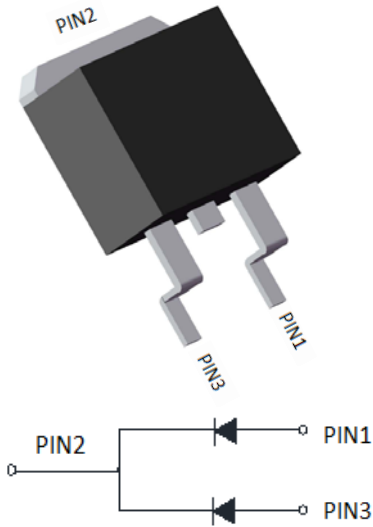

Features

- High frequency operation
- High purity, high temperature epoxy encapsulation for enhanced mechanical strength and moisture resistance
- Guard ring for enhanced ruggedness and long term reliability
- Part no. with suffix "Q" means AEC-Q101 qualified

Typical Applications

Typical applications are in switching power supplies, converters, automotive, freewheeling diodes, and reverse battery protection.

Mechanical Data

- **Package:** TO-263
Molding compound meets UL 94 V-0 flammability rating, RoHS-compliant
- **Terminals:** Tin plated leads, solderable per J-STD-002 and JESD22-B102
- **Polarity:** As marked

■Maximum Ratings (T_a=25°C Unless otherwise specified)

PARAMETER	SYMBOL	UNIT	MBRB4040CTQ
Device marking code			MBRB4040CT
Repetitive peak reverse voltage	V _{RRM}	V	40
Average Rectified Output Current @60Hz -sine wave, T _c =95°C	I _O	A	40
Forward Surge Current (Non-repetitive) @60Hz Half-sine wave, 1 cycle, T _a =25°C	I _{FSM}	A	300
Current Squared Time @1ms≤t≤8.3ms T _J =25°C	I ² t	A ² s	373
Storage Temperature	T _{stg}	°C	-55 ~ +150
Junction Temperature	T _J	°C	-55 ~ +150

■Electrical Characteristics (T_a=25°C Unless otherwise specified)

PARAMETER	SYMBOL	UNIT	TEST CONDITIONS	Typ	Max	
Instantaneous forward voltage per diode	V _F	V	I _F =20A T _J =25°C	0.57	0.65	
			I _F =20A T _J =125°C	0.52	0.60	
Typical junction capacitance per diode	C _J	pF	V _R =4V, f=1 MHz	910	-	
Instantaneous reverse current per diode	I _R	mA	V _R =40V	T _J =25°C	-	0.1
				T _J =125°C	-	100



■ Characteristics (Typical)

Fig.1: Forward Current Derating Curve

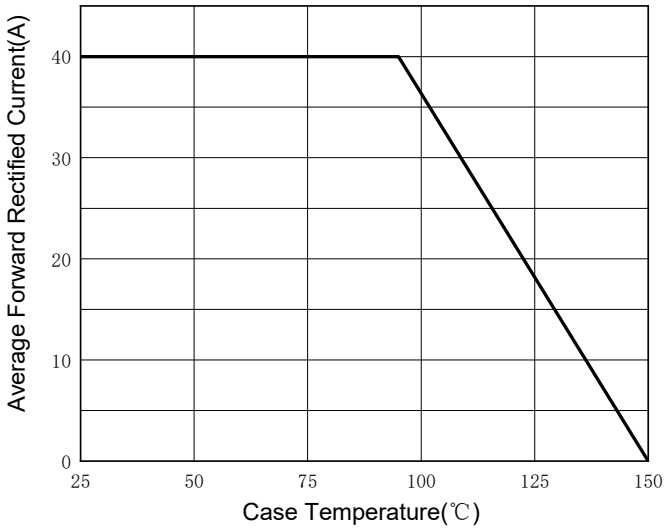

Fig.2: Forward Surge Current Capability(Per Diode)

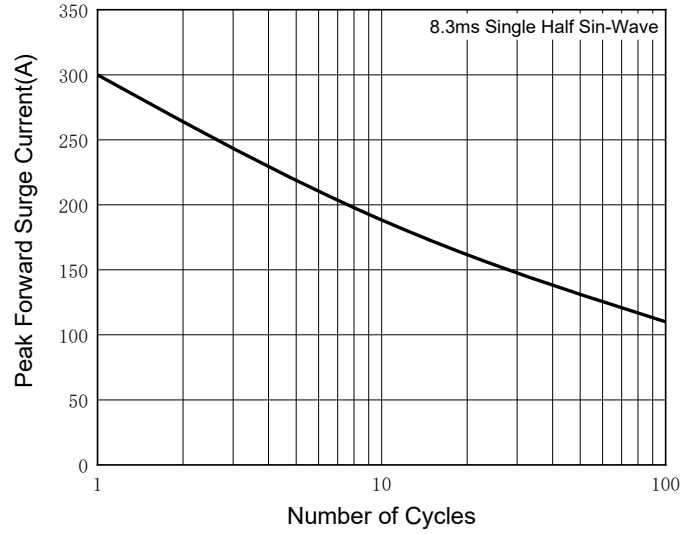

Fig.3: Typical Instantaneous Forward Characteristics(Per Diode)

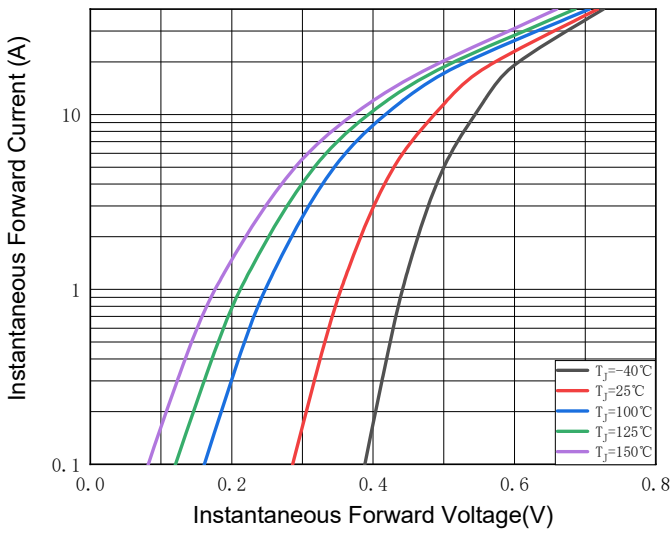

Fig.4: Typical Reverse Leakage Characteristics(Per Diode)

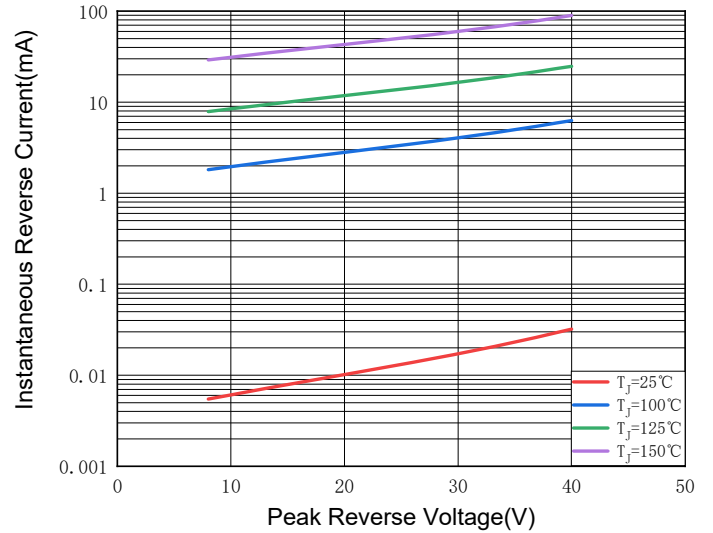
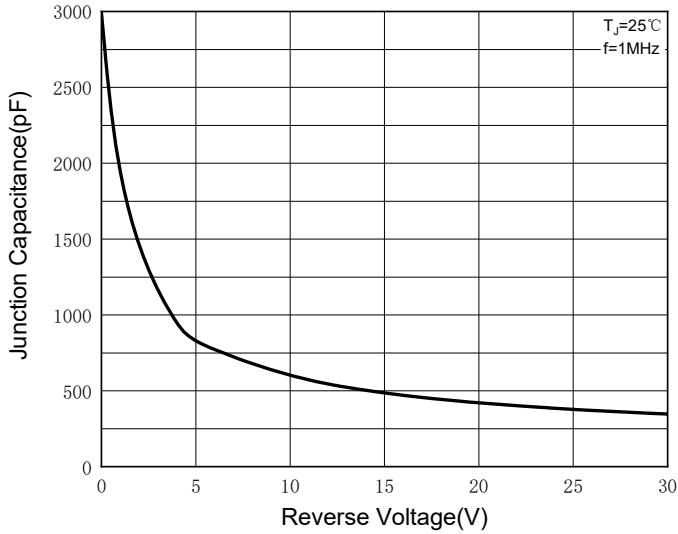

Fig.5: Typical Junction Capacitance(Per Diode)





MBRB4040CTQ

■ Thermal Characteristics ($T_a=25^\circ\text{C}$ Unless otherwise specified)

PARAMETER	SYMBOL	UNIT	MBRB4040CTQ
Typical thermal resistance per diode	$R_{\theta J-A}$	$^\circ\text{C/W}$	40 ⁽¹⁾
	$R_{\theta J-C}$	$^\circ\text{C/W}$	4 ⁽¹⁾

Note:

(1) Thermal resistance from junction to ambient and from junction to case mounted on P.C.B with 25.4mm*25.4mm copper pad areas.

■ Ordering Information (Example)

PREFERED P/N	UNIT WEIGHT(g)	MINIIMUM PACKAGE(pcs)	INNER BOX QUANTITY(pcs)	OUTER CARTON QUANTITY(pcs)	DELIVERY MODE
MBRB4040CTQ	Approximate 1.43	1000	2000	10000	Reel

■ Outline Dimensions

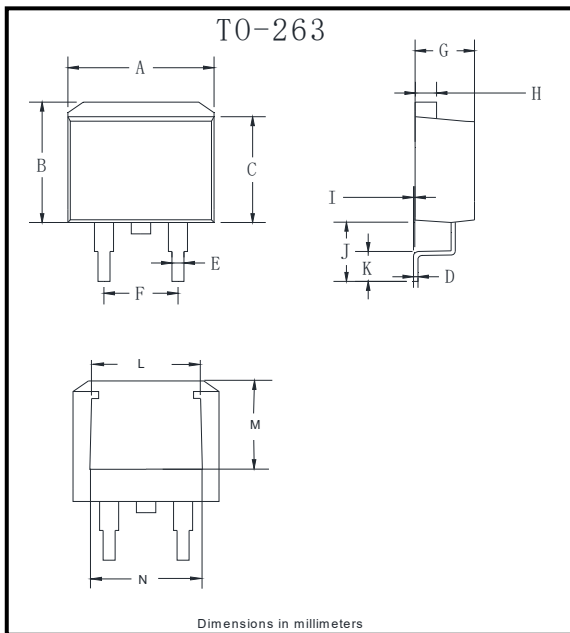

TO-263		
Dim	Min	Max
A	9.5	10.5
B	9.7	10.5
C	8.4	9.0
D	0.28	0.64
E	0.68	0.94
F	4.55	5.6
G	4.04	5.10
H	1.14	1.4
I	0	0.2
J	4.9	6.05
K	1.79	2.79
L	7.3	7.9
M	6.2	6.8
N	7.6	8.2

■ Suggested Pad Layout

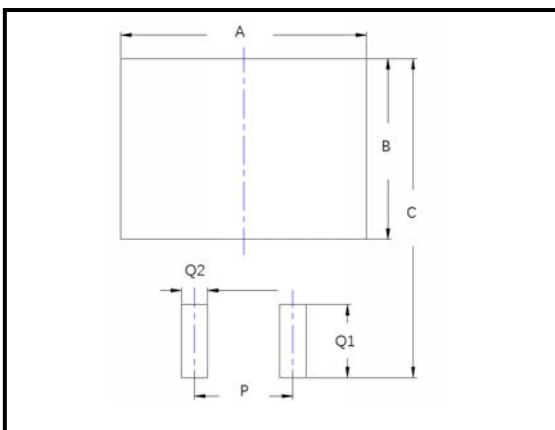

Dim	Millimeters
A	12.7
B	9.4
C	16.6
P	5.08
Q1	3.8
Q2	1.35



MBRB4040CTQ

Disclaimer

The information presented in this document is for reference only. Yangzhou Yangjie Electronic Technology Co., Ltd. reserves the right to make changes without notice for the specification of the products displayed herein to improve reliability, function or design or otherwise.

The product listed herein is designed to be used with automotive electronics, are not designed for use in medical, lifesaving, lifesustaining, or military, Yangjie or anyone on its behalf, assumes no responsibility or liability for any damages resulting from such improper use of sale.

This publication supersedes & replaces all information previously supplied. For additional information, please visit our website [http:// www.21yangjie.com](http://www.21yangjie.com) , or consult your nearest Yangjie's sales office for further assistance.