



## Glass Passivated Rectifier Diode Modules

**VRRM** 800 to 1800V  
**IFAV** 165 A

### Applications

- Non-controllable rectifiers for AC/AC converters
- Line rectifiers for transistorized AC motor controllers
- Field supply for DC motors
- PV combiner box

### Features

- Blocking voltage:800 to 1800V
- Heat transfer through aluminum oxide DBC ceramic isolated metal baseplate
- Glass passivated chip

**Circuit**

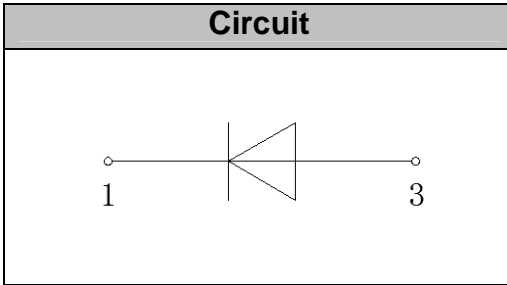

### Module Type

TYPE	VRRM	VRSM
MD165U08D2	800V	900V
MD165U12D2	1200V	1300V
MD165U16D2	1600V	1700V
MD165U18D2	1800V	1900V

### Maximum Ratings

Symbol	Conditions	Values	Units
IFAV	Single phase ,half wave 180° conduction Tc=101°C	165	A
IFSM	t=10mS Tvj =45°C	6000	A
i <sup>2</sup> t	t=10mS Tvj =45°C	180000	A <sup>2</sup> s
V <sub>isol</sub>	a.c.50HZ;r.m.s.;1min	3000	V
T <sub>vj</sub>		-40 to +150	°C
T <sub>stg</sub>		-40 to +125	°C
Mt	To terminals(M6)	5±15%	Nm
Ms	To heatsink(M6)	5±15%	Nm
Weight	Module (Approximately)	160	g

### Thermal Characteristics

Symbol	Conditions	Values	Units
R <sub>th(j-c)</sub>	Per diode	0.21	°C/W
R <sub>th(c-s)</sub>	Module	0.05	°C/W

### Electrical Characteristics

Symbol	Conditions	Values			Units
		Min.	Typ.	Max.	
V <sub>FM</sub>	T=25°C IF =300A	—	1.10	1.20	V
I <sub>RD</sub>	Tvj=150°C VRD=VRRM	—	—	9	mA



### Performance Curves

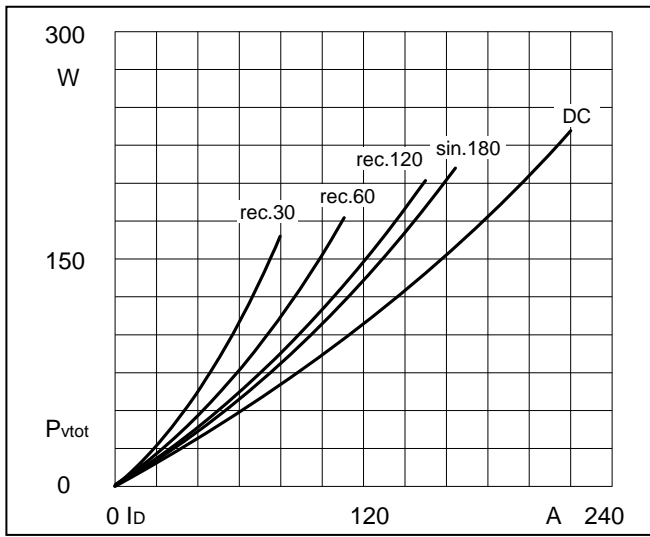

**Fig1. Power dissipation**

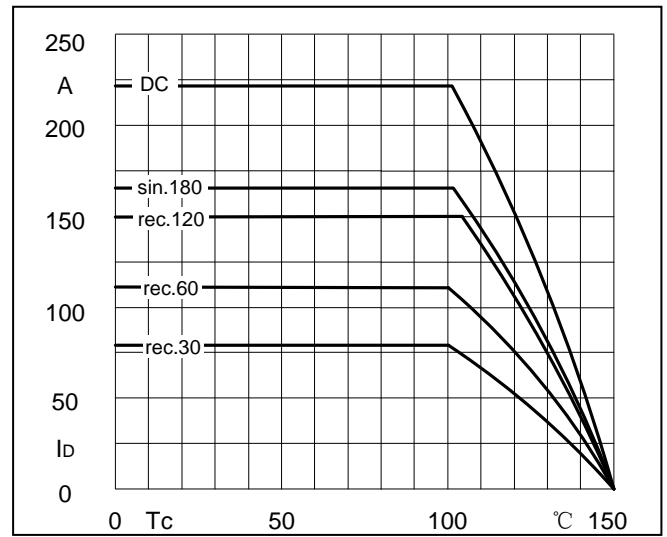

**Fig2. Forward Current Derating Curve**

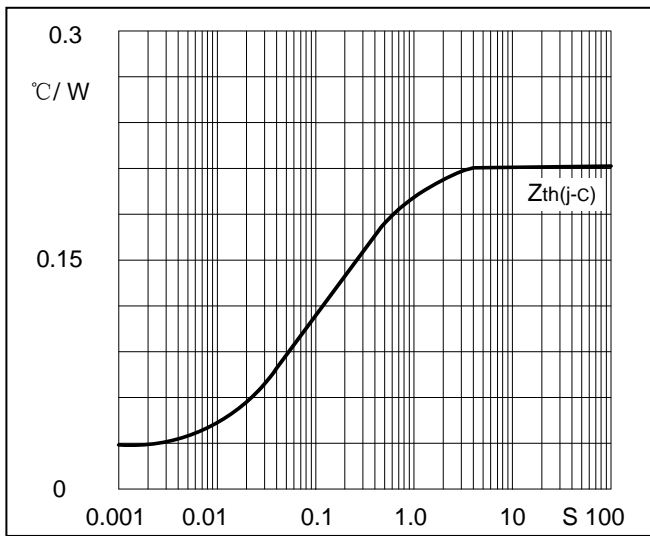

**Fig3. Transient thermal impedance**

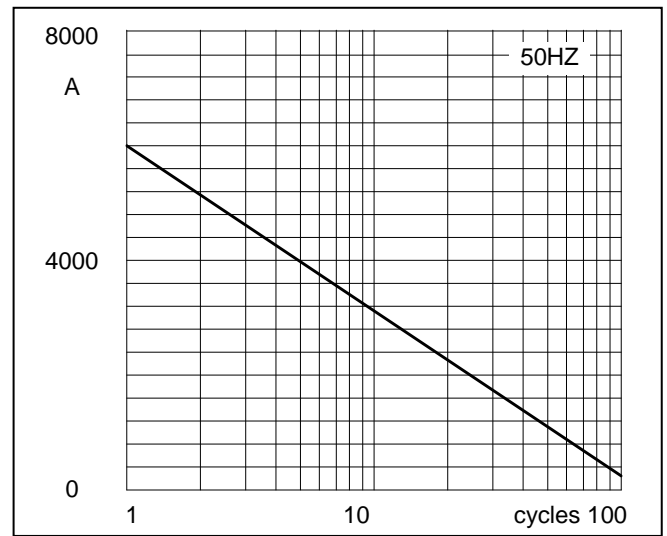

**Fig4. Max Non-Repetitive Forward Surge Current**

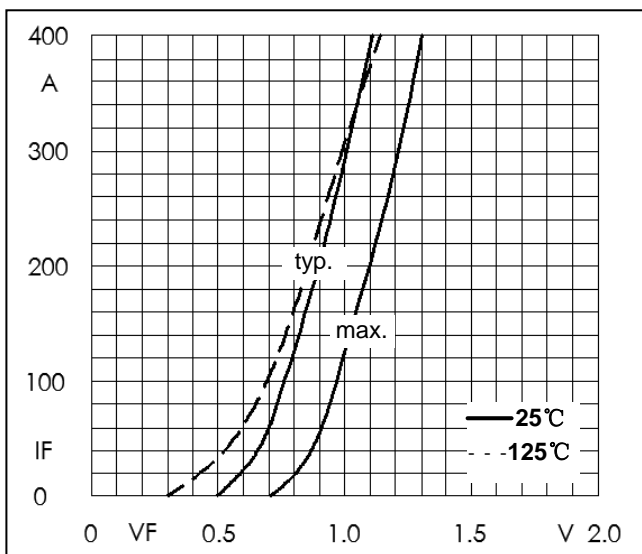

**Fig5. Forward Characteristics**

## Package Outline Information

CASE: D2

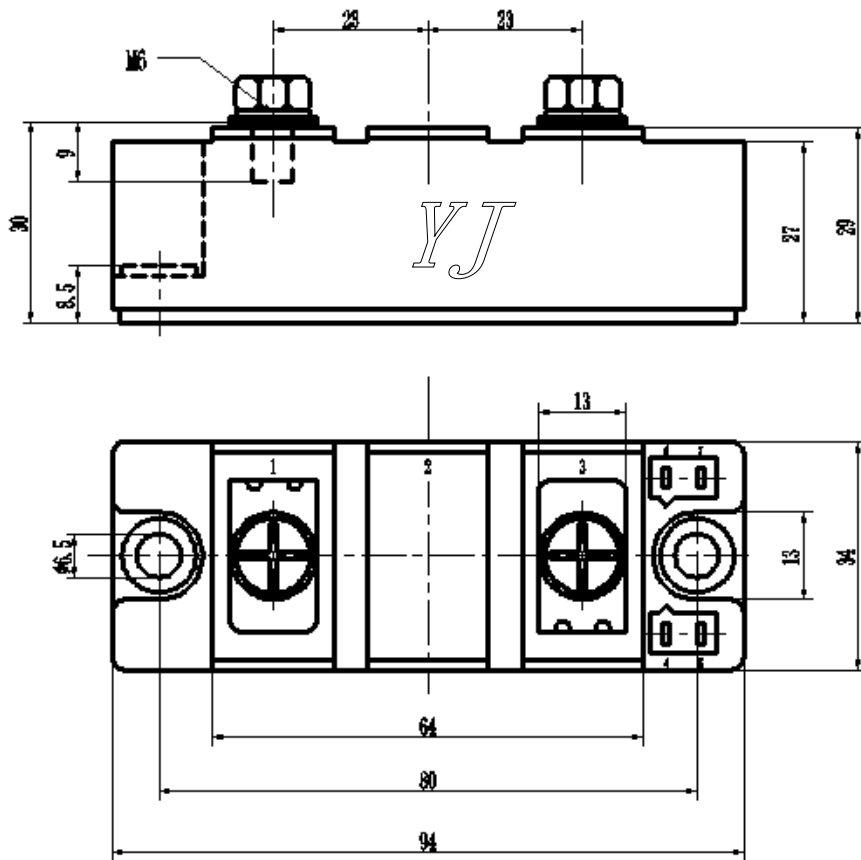

Dimensions in mm