

IGBT Discrete

V_{CE}	650	V
I_C	50	A
$V_{CE(SAT)} I_C=50A$	1.70	V

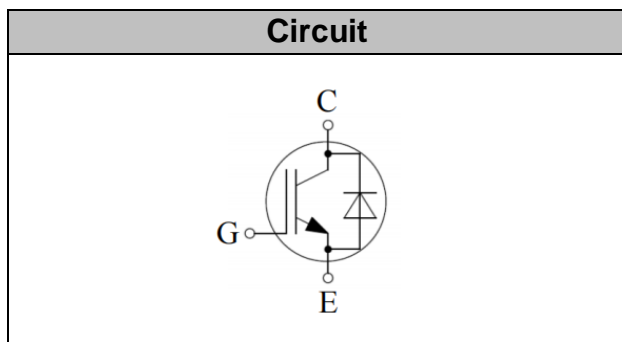

Applications

- Frequency Converters
- Uninterruptible power supply
- Motion/servo control

Features

- Low switching losses
- Maximum junction temperature 175°C
- Positive temperature coefficient
- High ruggedness, temperature stable
- High short circuit capability(5us)

Maximum Ratings

Parameter	Symbol	Value	Unit
Collector-Emitter Breakdown Voltage	V_{CE}	650	V
DC Collector Current, limited by T_{jmax} $T_C=25^\circ C$ $T_C=100^\circ C$	I_C	85 50	A
Diode Forward Current, limited by T_{jmax} $T_C=25^\circ C$ $T_C=100^\circ C$	I_F	85 50	A
Continuous Gate-Emitter Voltage	V_{GE}	± 20	V
Transient Gate-Emitter Voltage ($t_p \leq 10\mu s, D < 0.010$)	V_{GE}	± 30	V
Turn off Safe Operating Area $V_{CE} \leq 650V$, $T_j \leq 150^\circ C$		200	A
Pulsed Collector Current, $V_{GE}=15V$, t_p limited by T_{jmax}	I_{CM}	200	A
Diode Pulsed Current, t_p limited by T_{jmax}	I_{Fpuls}	200	A
Short Circuit Withstand Time, $V_{GE}=15V, V_{CC}=400V, V_{CEM} \leq 650V$	T_{sc}	5	μs
Power Dissipation, $T_j=175^\circ C, T_c=25^\circ C$	P_{tot}	300	W



Operating Junction Temperature	T_j	-40...+175	°C
Storage Temperature	T_s	-55...+150	°C
Soldering Temperature, wave soldering 1.6mm (0.063in.) from case for 10s		260	°C

Electrical Characteristics of the IGBT ($T_j = 25^\circ\text{C}$ unless otherwise specified):

Parameter	Symbol	Conditions	Min.	Typ.	Max.	Unit
Static						
Collector-Emitter Breakdown Voltage	BV_{CES}	$V_{GE}=0V, I_C=250\mu A$	650		-	V
Gate Threshold Voltage	$V_{GE(th)}$	$V_{GE}=V_{CE}, I_C=0.8mA$	4.1	5.1	6.1	V
Collector-Emitter Saturation Voltage	$V_{CE(sat)}$	$V_{GE}=15V, I_C=50A$ $T_j=25^\circ\text{C}$, $T_j=125^\circ\text{C}$ $T_j=150^\circ\text{C}$		1.70 1.90 2.00	2.10	V
Zero Gate Voltage Collector Current	I_{CES}	$V_{CE}=650V, V_{GE}=0V$ $T_j=25^\circ\text{C}$, $T_j=150^\circ\text{C}$			0.25 4.00	mA
Gate-Emitter Leakage Current	I_{GES}	$V_{CE}=0V, V_{GE}=\pm 20V$			100	nA

Parameter	Symbol	Conditions	Min.	Typ.	Max.	Unit
Dynamic						
Input Capacitance	C_{ies}	$V_{CE}=25V, V_{GE}=0V,$ $f=1MHz$	-	2.10	-	nF
Reverse Transfer Capacitance	C_{res}		-	0.08	-	
Gate Charge	Q_G	$V_{CC}=300V, I_C=50A,$ $V_{GE}=15V$	-	0.21	-	uC
Short Circuit Collector Current	I_{SC}	$V_{GE}=15V, t_{sc}\leq 5\mu s,$ $V_{CC}=400V, T_j\leq 150^\circ\text{C}$	-	250	-	A

**Electrical Characteristics of the Diode** ($T_j = 25^\circ\text{C}$ unless otherwise specified):

Parameter	Symbol	Conditions	Min.	Typ.	Max.	Unit
Static						
Diode Forward Voltage	V_F	$I_F = 50\text{A}$ $T_j = 25^\circ\text{C}$, $T_j = 125^\circ\text{C}$ $T_j = 150^\circ\text{C}$		2.30 2.00 1.90	2.90	V

Switching Characteristic, Inductive Load

Parameter	Symbol	Conditions	Min.	Typ.	Max.	Unit
Dynamic , at $T_j = 25^\circ\text{C}$						
Turn-on Delay Time	$t_{d(on)}$	$V_{CC} = 400\text{V}$, $I_C = 50\text{A}$, $V_{GE} = 0\text{V} \sim 15\text{V}$, $R_g = 10\Omega$	-	17	-	ns
Rise Time	t_r		-	50	-	ns
Turn-on Energy	E_{on}		-	2.20	-	mJ
Turn-off Delay Time	$t_{d(off)}$		-	167	-	ns
Fall Time	t_f		-	77	-	ns
Turn-off Energy	E_{off}		-	1.39	-	mJ
Dynamic , at $T_j = 125^\circ\text{C}$						
Turn-on Delay Time	$t_{d(on)}$	$V_{CC} = 400\text{V}$, $I_C = 50\text{A}$, $V_{GE} = 0\text{V} \sim 15\text{V}$, $R_g = 10\Omega$	-	16	-	ns
Rise Time	t_r		-	48	-	ns
Turn-on Energy	E_{on}		-	2.18	-	mJ
Turn-off Delay Time	$t_{d(off)}$		-	172	-	ns
Fall Time	t_f		-	86	-	ns
Turn-off Energy	E_{off}		-	1.89	-	mJ
Dynamic , at $T_j = 150^\circ\text{C}$						
Turn-on Delay Time	$t_{d(on)}$	$V_{CC} = 400\text{V}$, $I_C = 50\text{A}$, $V_{GE} = 0\text{V} \sim 15\text{V}$, $R_g = 10\Omega$	-	15	-	ns
Rise Time	t_r		-	46	-	ns
Turn-on Energy	E_{on}		-	2.16	-	mJ
Turn-off Delay Time	$t_{d(off)}$		-	179	-	ns
Fall Time	t_f		-	97	-	ns
Turn-off Energy	E_{off}		-	2.25	-	mJ



Electrical Characteristics of the DIODE

Parameter	Symbol	Conditions	Min.	Typ.	Max.	Unit
Dynamic , at T_j= 25°C						
Reverse Recovery Current	I _{rr}	I _F =50A, V _R =400V di/dt= -400A/μs,	-	6	-	A
Reverse Recovery Charge	Q _{rr}		-	0.32	-	uC
Diode reverse recovery time	trr		-	141	-	ns
Reverse Recovery Energy	E _{rec}		-	0.05	-	mJ
Dynamic , at T_j= 125°C						
Reverse Recovery Current	I _{rr}	I _F =50A, V _R =400V di/dt= -400A/μs,	-	8	-	A
Reverse Recovery Charge	Q _{rr}		-	0.84	-	uC
Diode reverse recovery time	trr		-	163	-	ns
Reverse Recovery Energy	E _{rec}		-	0.13	-	mJ
Dynamic , at T_j= 150°C						
Reverse Recovery Current	I _{rr}	I _F =50A, V _R =400V di/dt= -400A/μs,	-	10	-	A
Reverse Recovery Charge	Q _{rr}		-	1.18	-	uC
Diode reverse recovery time	trr		-	172	-	ns
Reverse Recovery Energy	E _{rec}		-	0.18	-	mJ

Thermal Resistance

Parameter	Symbol	Max. Value	Unit
IGBT Thermal Resistance, Junction - Case	R _{th(j-c)}	0.50	K/W
Diode Thermal Resistance, Junction - Case	R _{th(j-c)}	1.05	K/W
Thermal Resistance, Junction - Ambient	R _{th(j-a)}	40	K/W

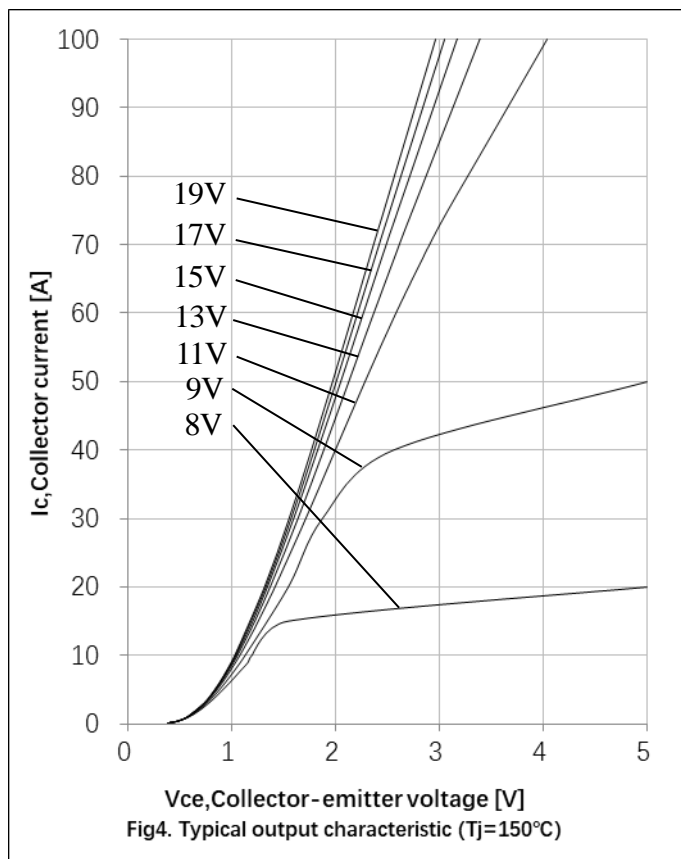
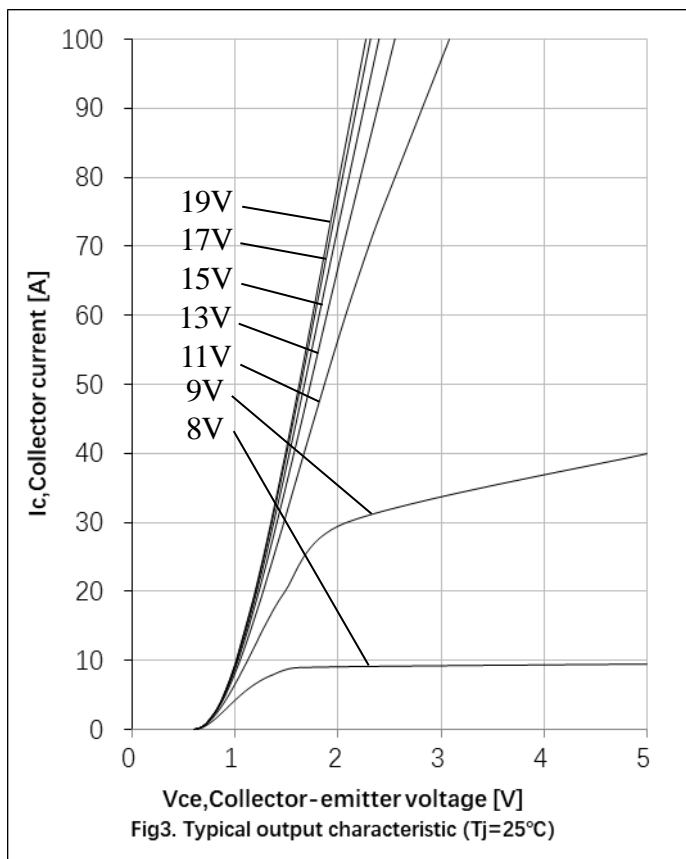
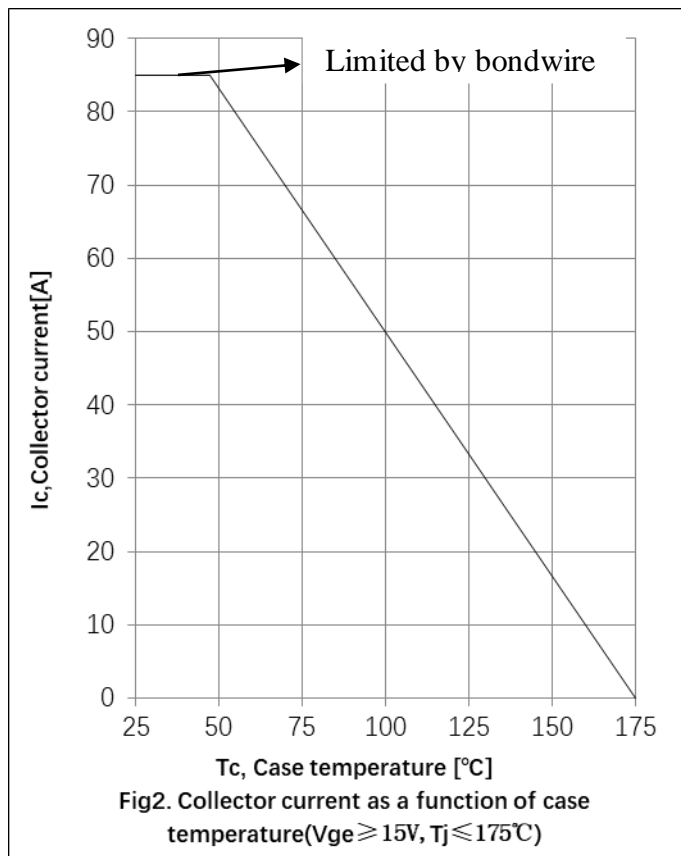
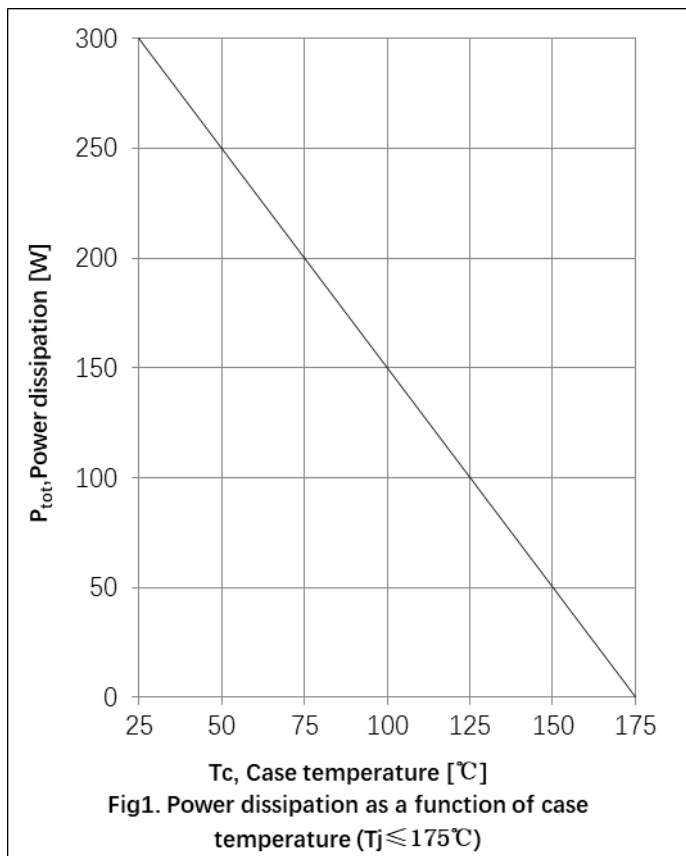

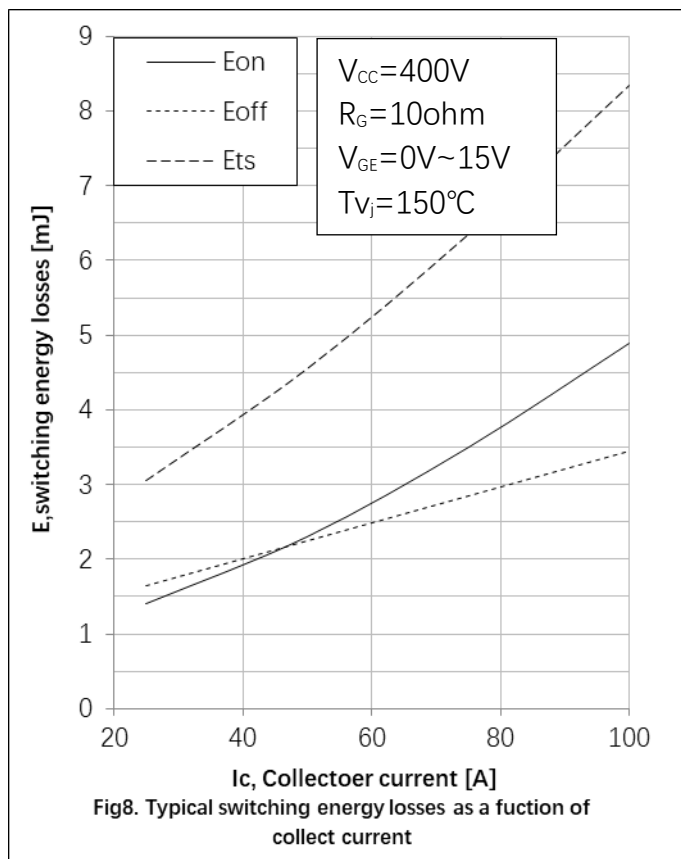
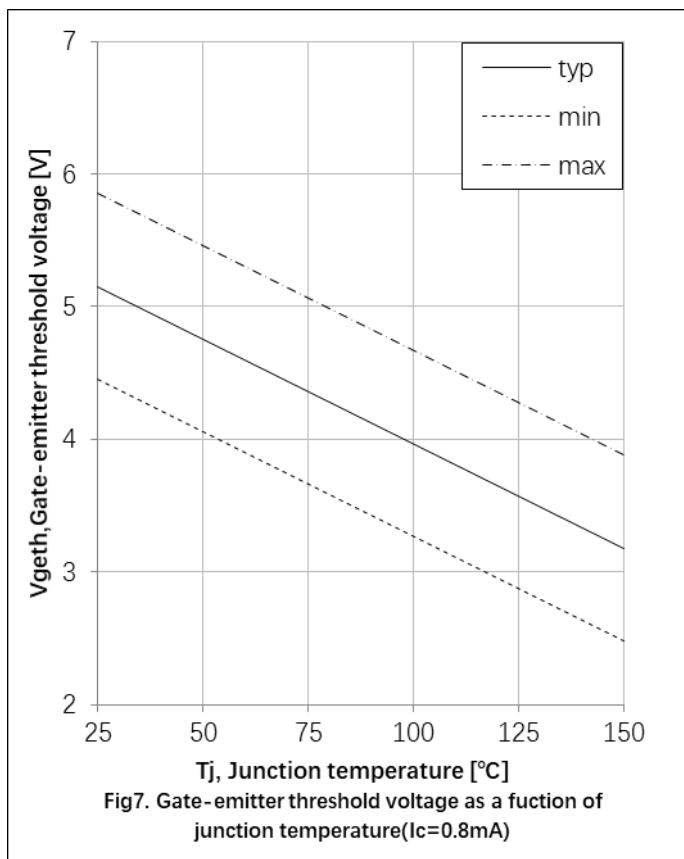
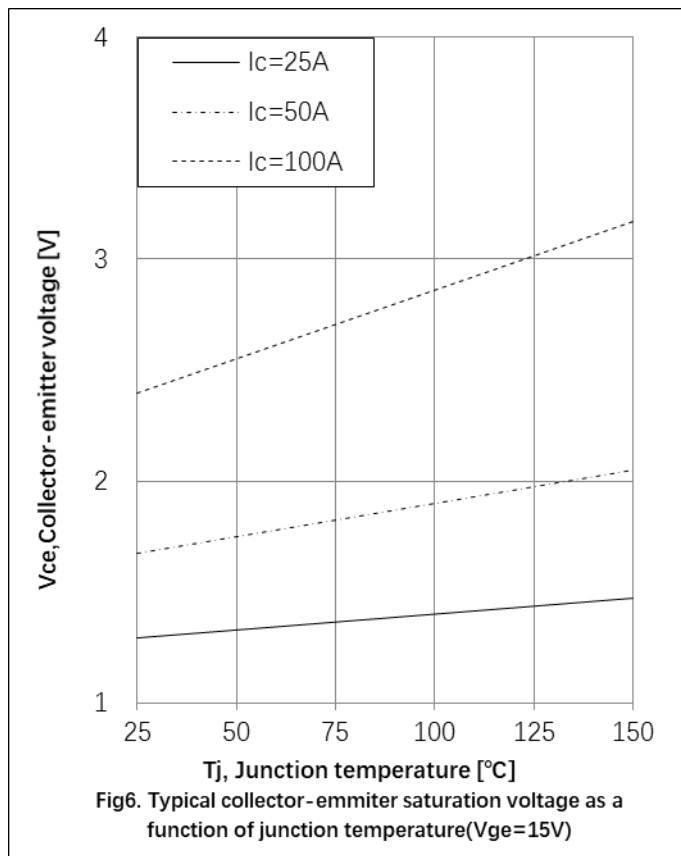
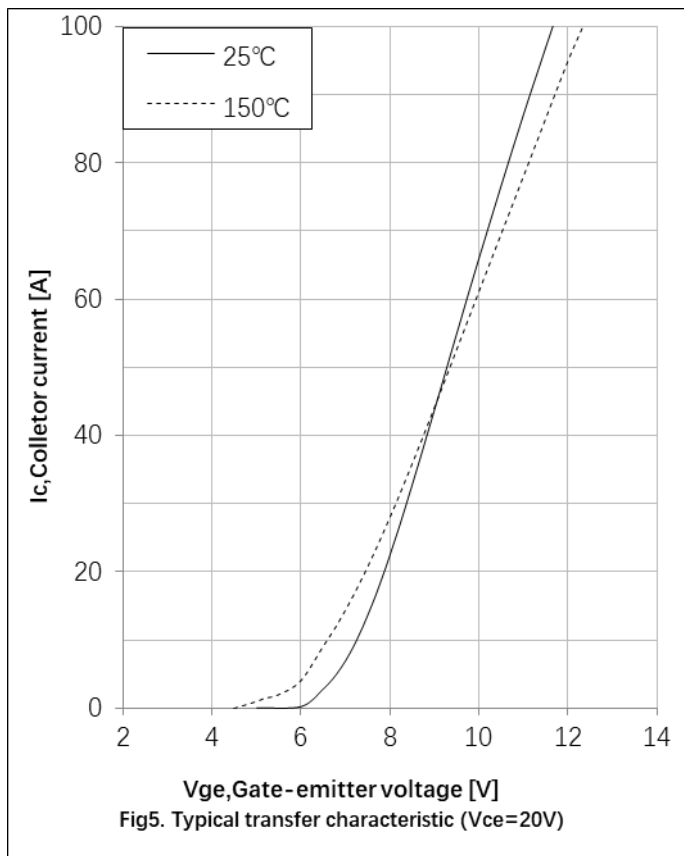

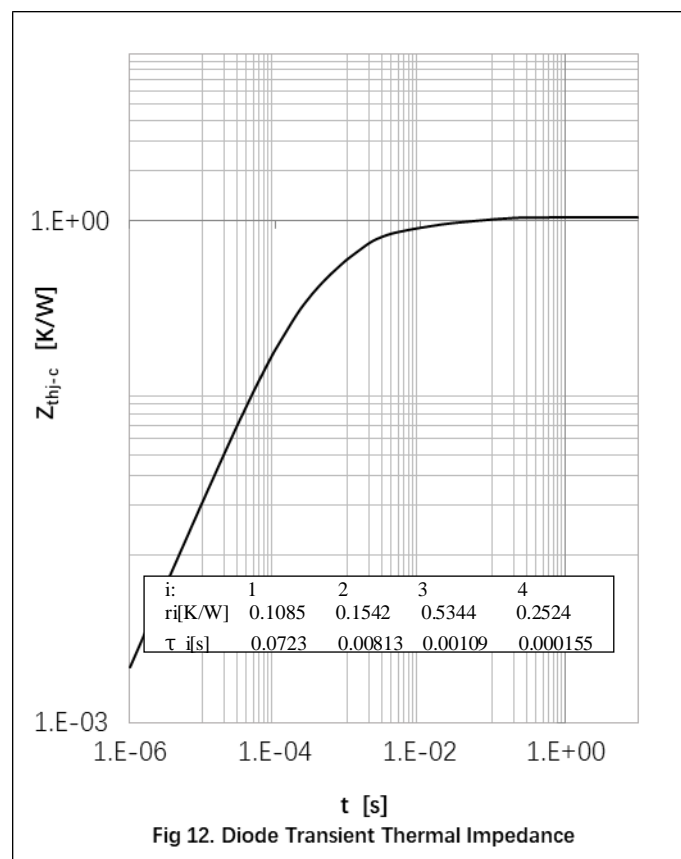
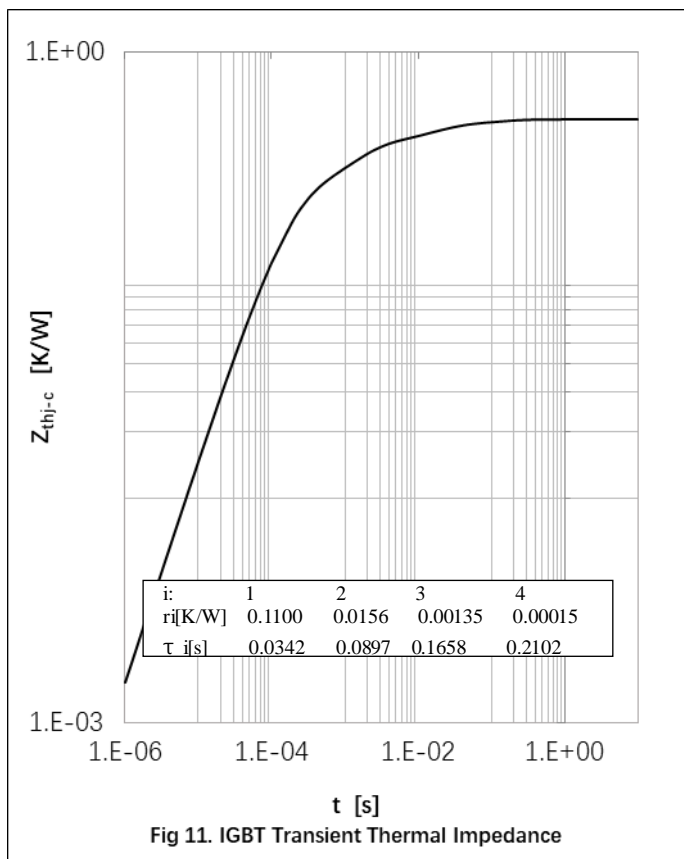
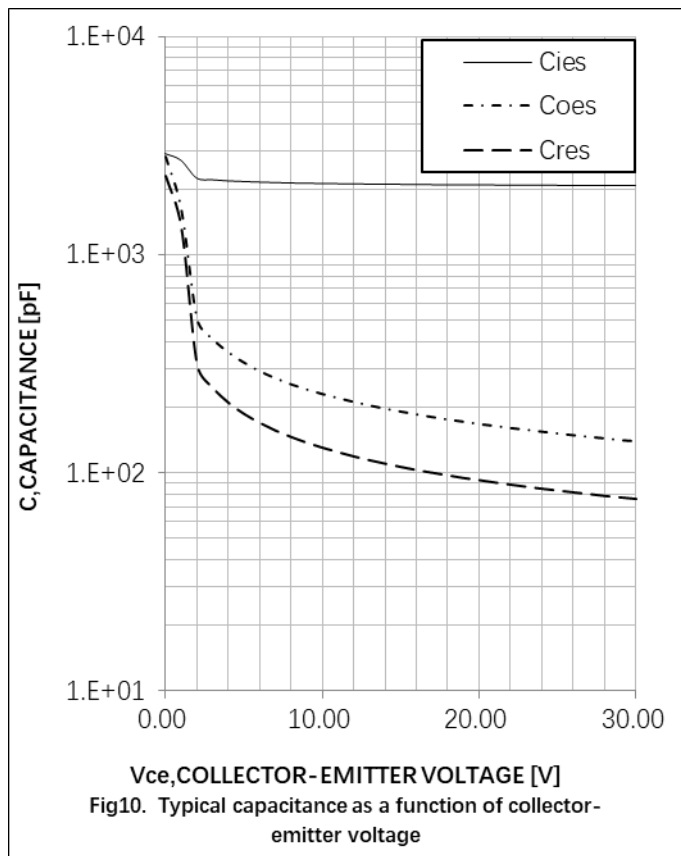
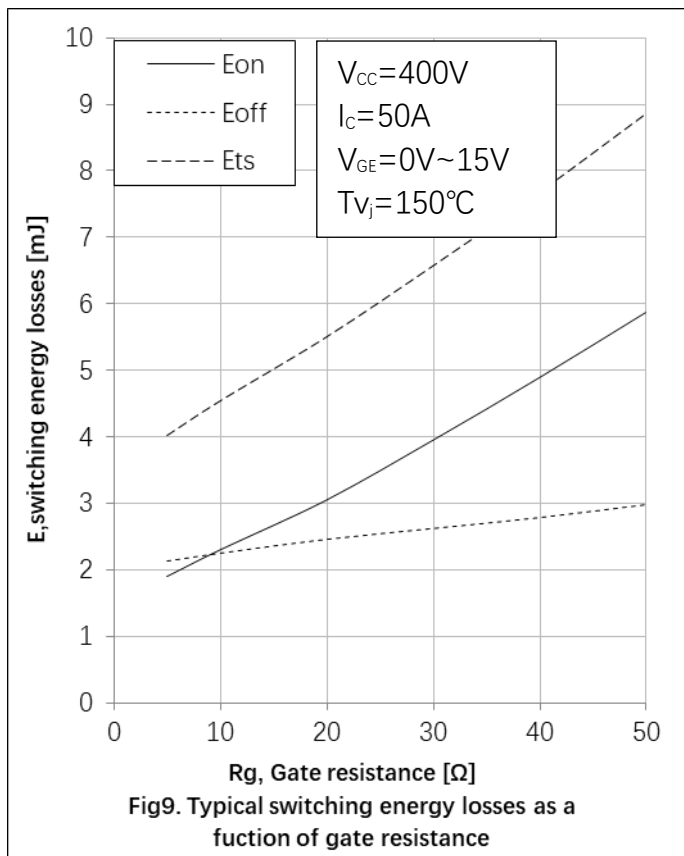

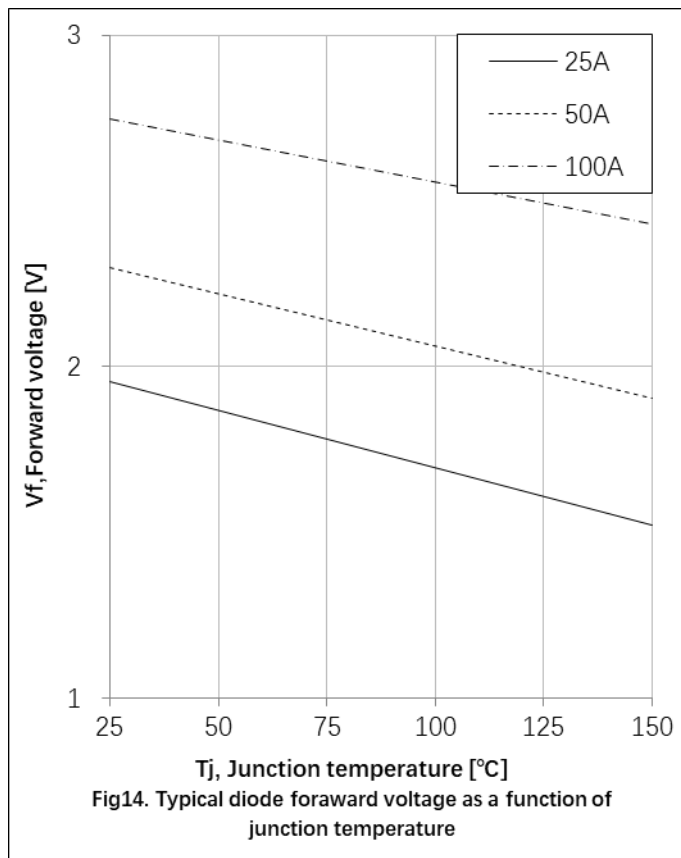
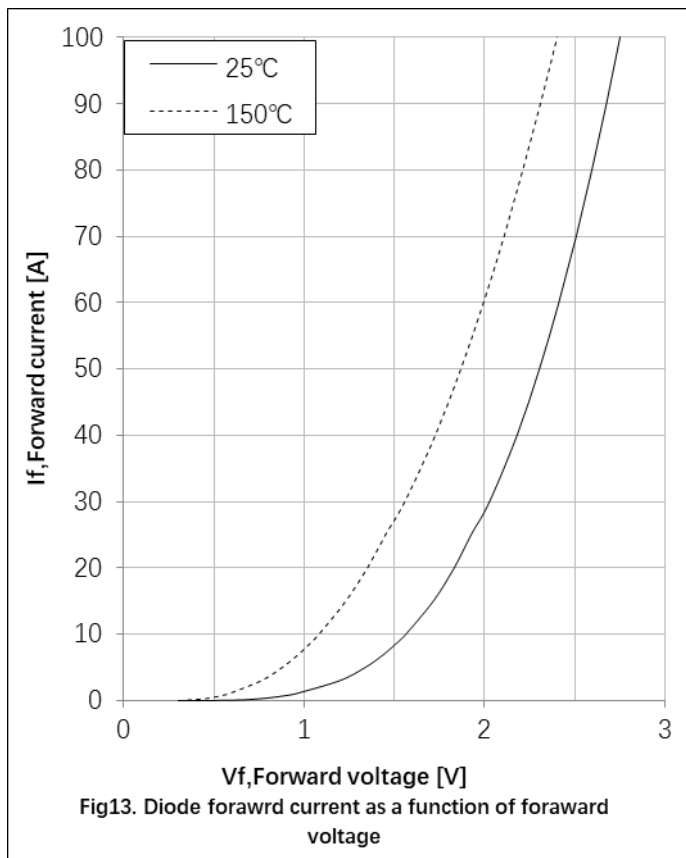

● **Circuit Diagram**

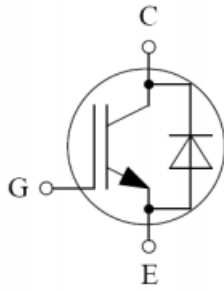

● **Package Outline Information**

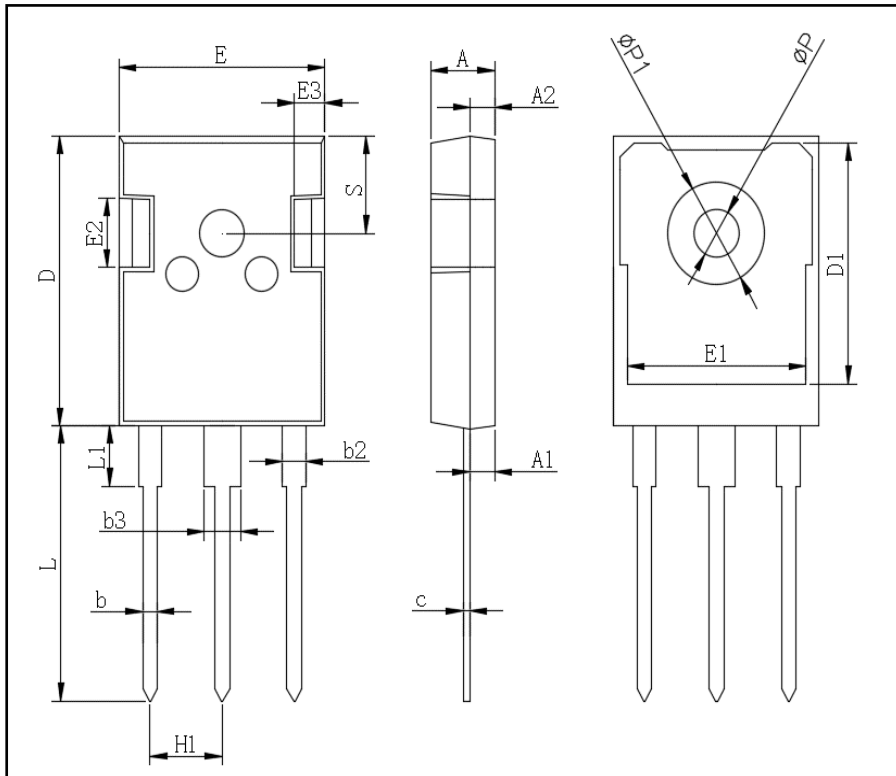

TO-247AB		
Dim	Min	Max
A	4.80	5.20
A1	2.21	2.61
A2	1.85	2.15
b	1.0	1.4
b2	1.91	2.21
C	0.5	0.7
D	20.70	21.30
D1	16.25	16.85
E	15.50	16.10
E1	13.0	13.6
E2	4.80	5.20
E3	2.30	2.70
L	19.62	20.22
L1	-	4.30
Φ P	3.40	3.80
Φ P1	-	7.30
S	6.15TYP	
H1	5.44TYP	
b3	2.80	3.20